

005506 | SMARTSTATION®

UNDERMOUNT STAINLESS STEEL KITCHEN SINK

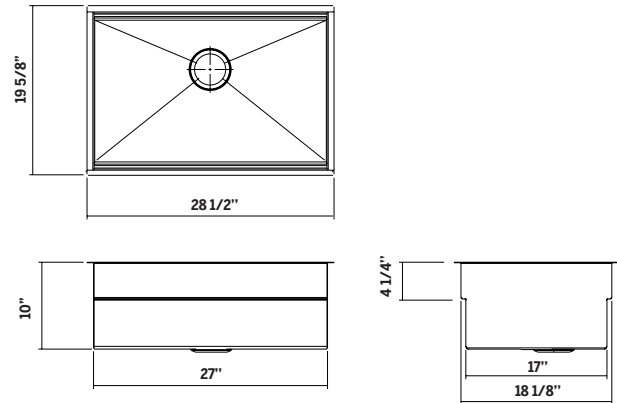

Specifications

Model	005506
Collection	SmartStation®
Bowl dimensions	27" x 18 1/8" x 10"
Overall dimensions	28 1/2" x 19 5/8" x 10"
Recommended cabinet	30"

Recommended accessories

Drain	100082
Grid	200913

	Walnut	Maple
Cutting board	210067	210068
Serving bin with bowls (2)	225212	225312
Serving board with bowl and colander	225208	225308
Drying rack	215207	215307
Colander	205225	205325
Serving board with bowls (2)	225203	225303

And many more

Warranty

Home Refinements offers a LIMITED LIFETIME WARRANTY on the fixed components of its stainless steel sinks against defects of material and workmanship as well as a 1-YEAR LIMITED WARRANTY following the purchase date for all accessories against defects of material and workmanship. This warranty is limited to defects or damages resulting from a normal residential use. For further details on our product warranty, please refer to our catalog or Web site.

Features

- Handcrafted in Canada
- Commercial quality stainless steel 16 ga thickness
- Corrosion resistant material 304 series (18/10)
- Unique design allowing the Home Refinements standard accessories to slide one over the other on two levels
- 1/2" accessory ledge on front and back of the bowl to accommodate any standard 17" Home Refinements accessory (accessories not included)
- Standard 18" Home Refinements accessories to be used directly on the countertop (undermount with overhang countertop installation necessary) (accessories not included)
- Attractive combination of UrbanEdge® and J7® collections : vertical square corners [0mm] and slightly rounded corners [7mm] for bottom front and back folds
- Environmentally friendly product, 100% recyclable
- Elegant no. 4 brushed finish that matches the appliances
- Highly efficient sound deadening pads
- Practical flat sink bottom and straight bowl sides that maximize available space in the bowl
- Stylish and functional bowl bottom grooves that facilitate water drainage
- Rear or side 3-1/2" drain placement
- Mounting hardware included
- Certifications: ASME A112.19.3, CSA B45.0, CSA B45.4